

APL 4000 Series

The maximum expression in secondary packaging labeling

The APL 4000 has been designed for high-speed, secondary packing labeling.

The APL series units are systems projected to print and apply self-adhesive labels in multiple application methods; Linear, Dual -Tamp, Corner-Wrap and Air-Blow. They may be interfaced with a computer, on-line (Ethernet), and in real time apply the label just printed on either still or moving products. It is also equipped to work in stand-alone mode.

The APL 4000 Series can integrate the various A-CLASS thermal Transfer engines from DATAMAX, which have been specifically developed for its use on automatic applicators. The high performance achieved permits: resolution of 8 to 23 dots/mm., up to 300 mm/sec. printing speed and 4" or 6" of printable width.

In our APL units, mechanics, pneumatics and electronics have been properly integrated to aim all requirements of machinery that operates in industrial environments. Consequently its structure is formed by a high quality components and standard devices engineered for the application of labels in any point; top, side, front and rear at high linear speeds.

As a result, APL 4000 becomes a complete system for the identification of packages, such as boxes, cases, bundles, etc., reaching high levels of accuracy and reliability, offering easy use and maintenance as well as flexibility and accessibility to all production line.

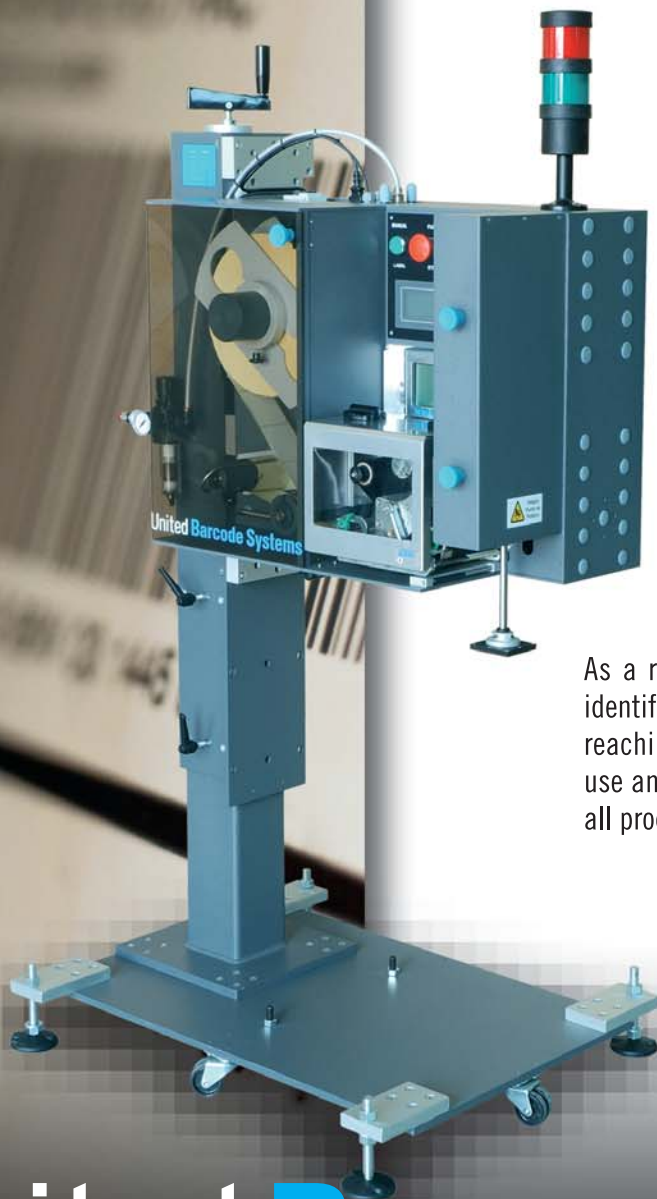





UBS

United Barcode Systems

APL 4000 Series Specifications

GENERAL DESCRIPTION	SECONDARY PACKAGING REAL TIME LABELS PRINT & APPLY SYSTEM
PRINT ENGINE	DATAMAX, SATO & ZEBRA
PRINT RESOLUTION	From 203 to 600 dpi
LABEL/RIBBON ROLL	Label roll: Diameter max: 10,2 in. Ribbon roll: Length max.: 2952 ft.
SOFTWARE	DPL protocol / MCL language
MEMORY	4 MB FLASH downloadable program memory, 16 MB DRAM memory
INTERFACE	RS-232 serial, 9 pin. RS-422/RS-485, USB v1.1. IEEE 1284 parallel. ETHERNET Optional
KEYBOARD & DISPLAY	Graphics LCD control display with backlight. EFIGSlanguages. 5 function keys keyboard. Touch Screencontrol keyboard
POWER SUPPLY	110/220 VAC, 50 ó 60 Hz.
DIMENSIONS	Height from 42,3228 in. to 72,4409 in. (Other heights available). Print & Apply Unit: 16,5354 x 14,5669 x 28,3465 in. Base: 35,4331 x 40,1575 in.
WEIGHT	Including support: 385,8 lbs
ENVIRONMENT	From +41° F to +100,4° F
HUMIDITY	20-85% non-condensing

APPLICATON METHOD	LABEL WIDTH*	LABEL LENGHT*	SPEED**	TYPICAL APPLICATIONS	LABELING CONFIGURATIONS
 LINEAL	40 mm. to 114 mm. (1,57" to 4,48")	40 to 150 mm. (1,57" to 6")	Up to 50 labels/ minute	Cases, Boxes, Cartons and all package goods	Top and side
 SOPLADO/EXPULSION	40 mm. To 75 mm. (1,57 to 2,95")	40 mm. To 75 mm. (1,57 to 2,95")	Up to 70 labels/ minute	Non Contact packing application	Top and side
 CORNER	70 mm. To 114 mm. (2,75 to 4,48")	150 mm. to 205 mm. (6 to 8")	Up to 32 Labels/minute	Cases, Boxes and cartons	Adjacent panels
 DOBLE ETIQUETA	70 mm. To 114 mm. (2,75 to 4,48")	105 mm. To 150 mm. (4,13 to 6")	Up to 32 labels/minute	Cases, Boxes and cartons	Front, Side or Rear
 ROTATIVO	80 mm. To 75 mm. (3,15 to 2,95")	40mm. To 80 mm. (1,57 to 3,15 ")	Up to 25 labels/ minute	Cases, Boxes and cartons	Front or Rear

We reserve the right to amend the design and/or specifications of our products without notice

*Depending upon product handling **Depending upon data communication, applicator length, and label size

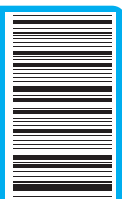

Labeling, Coding and Marking Solutions United Barcode Systems

www.ubscod.com

UBS HEADQUARTERS	(+34) 902 127 721	info@ubscod.com
UBS NORTH AMERICA	(+1) (760)480 0777	infousa@ubscod.com
UBS SPAIN	(+34) 902 195 591	info@ubscod.com
UBS ITALY	(+39) 0224 972 132	info.italy@ubscod.com
UBS MÉXICO	(+52) 55 5572 4892	infomexico@ubscod.com